

HOTEL OS&E

酒店家具及营业供应与器材

产品, 材料及色卡

20/21



Kian® 健

BETTER DESIGN, BETTER VALUE, BETTER WORLD

目录

关于我们	07
什么是酒店运营用品及设备(Hotel OS&E)	09
您将获得的服务价值	11
酒店运营用品及设备	
椅子	13
桌子	27
活动讲台	45
前台服务	51
后勤服务	55
客房服务	73
材料与色卡	75



关于我们

KIAN作为全球家具行业的领导者,拥有数十年的经验。我们之所以在这一领域处于领先地位,因为我们投入了大量时间倾听客户的需求,并为他们提供解决方案。作为一家出口到全球100多个国家的全方位家具解决方案供应商,我们设计、制造并直接供应给商用和家居用户。KIAN拥有遍布全球的物流网络、仓储设施和专业的本地团队为客户提供服务。

KIAN提供原创设计,以及专门为酒店和住宿行业定制的产品。我们会灵活的提供全面的方案,可以根据您所要求的预算和风格进行定制。或者,如果您需要,我们还提供项目管理服务,全程监督您的项目。

什么是 HOTEL OS&E

Hotel OS&E Operating Supplies & Equipment 是指酒店的运营用品及设备,为了您酒店的家具和电器在运营过程中能展现出更高的配合度,到达灵活运用空间最优选。我们的产品和设备在工厂制造,避免大多不必要的组装,从而快速完成设店。

品类1

堆叠椅,桌椅&配件



品类2

讲台,舞台&配件



品类3

自助餐&配件



品类4

前台,客房服务,后勤推车&配件





您将获得的服务价值

01 我们的业务生态

值得信赖的提供全球服务品牌, KIAN的目标是为我们的客户提供最好的服务。

02 多区域供应链

凭借超过37年的行业经验, 我们已经发展了一个全球网络, 更好地服务于世界各地的客户。

03 实惠的价格

我们相信品牌应当得到更高价值。我们高性价比的产品, 令客户将付合理的价格获得高质量的家具。

04 项目管理与本地服务

从0至100, 让我们全程为您的项目管理。此外, 无论您在世界哪个地方我们会尽所能提供本地服务。

椅子

结合舒适和功能性而创造,我们的椅子能完美的符合移动和快节奏环境。椅子的框架是机械自动焊接表面粉末涂层保护,使其具有耐用性。座椅和靠背软垫使用高密度定型海绵。可堆叠多达10件,以节省空间,我们的椅子还设有加厚脚垫增强稳定性,在堆叠和防止滑行在不平坦的表面具有良好的表现。



特性:

- 机械自动焊接,表面粉末涂层
- 采用高密度定型海绵
- 耐用脚垫
- 堆叠多达10张



LUFFI 可堆叠铁艺 宴会椅

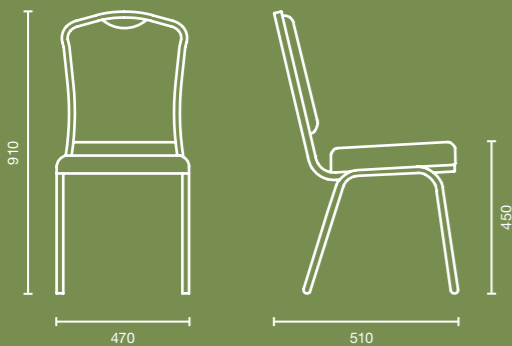

特性:

- 机械自动焊接, 表面粉末涂层
- 采用高密度定型海绵
- 耐用脚垫
- 堆叠多达10张



NMC - 001
W450 x D484 x H890mm



NMC - 002
W455 x D480 x H890mm



NMC - 003
W465 x D480 x H910mm



NMC - 004
W560 x D450 x H880mm



NMC - 005
W465 x D480 x H910mm



NMC - 006
W450 x D470 x H920mm



NMC - 007
W450 x D470 x H920mm



NMC - 008
W450 x D475 x H925mm



NMC - 009
W445 x D480 x H920mm



NMC - 010
W465 x D480 x H915mm



NMC - 011
W440 x D480 x H890mm



NMC - 012
W450 x D570 x H900mm



NMC - 013
W450 x D484 x H915mm



NMC - 014
W460 x D560 x H900mm

FRANKIE

可堆叠铝制宴会椅子

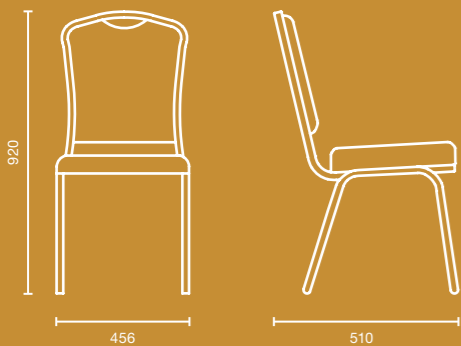

框架
25 x 25 x 2.2 Thick (mm)
高品质压制铝

- 特性:
- 机械自动焊接, 表面粉末涂层
 - 采用高密度定型海绵
 - 耐用脚垫
 - 堆叠多达10张



NAC - 001
W480 x D510 x H910mm



NAC - 002
W470 x D510 x H910mm



NAC - 003
W465 x D510 x H920mm



NAC - 004
W472 x D510 x H895mm



NAC - 005
W470 x D550 x H915mm



NAC - 006
W470 x D550 x H910mm



NAC - 007
W465 x D510 x H860mm



NAC - 008
W465 x D510 x H905mm



NAC - 009
W470 x D510 x H895mm



NAC - 010
W462 x D510 x H895mm



NAC - 011
W472 x D510 x H895mm



NAC - 012
W495 x D510 x H925mm



NAC - 013
W460 x D510 x H926mm

BROOK

可堆叠铝制宴会椅子

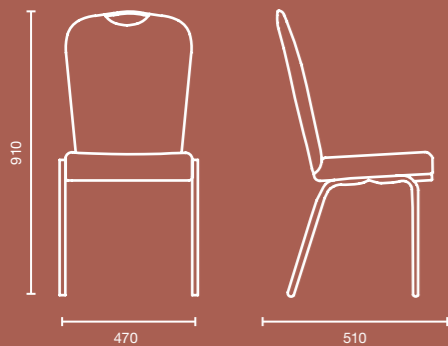

框架
25 x 25 x 2.2 Thick (mm)
高品质压制铝

- 特性:
- 机械自动焊接, 表面粉末涂层
 - 采用高密度定型海绵
 - 耐用脚垫
 - 堆叠多达10张



NFC - 001
W480 x D420 x H900mm



NFC - 002
W560 x D410 x H925mm



NFC - 003
W580 x D410 x H925mm



NFC - 004
W560 x D420 x H935mm



NFC - 005
W560 x D420 x H935mm



NFC - 006
W560 x D410 x H925mm



NFC - 007
W595 x D430 x H900mm



NFC - 008
W560 x D430 x H900mm



NFC - 009
W595 x D430 x H900mm

ROBIN 可堆叠铁艺 宴会椅

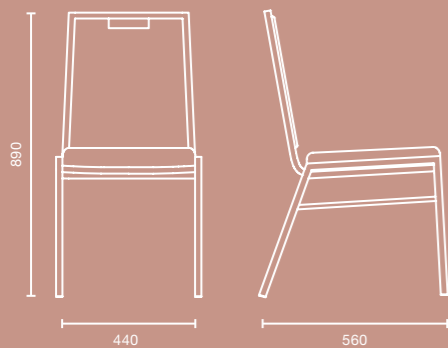

框架
19 x 19 x 1.6 Thick (mm)

- 特性:
- 机械自动焊接, 表面粉末涂层/电镀
 - 采用高密度定型海绵
 - 耐用脚垫
 - 堆叠多达10张



NCL - 001
W570 x D460 x H890mm



NCL - 003
W440 x D560 x H890mm



NCL - 004
W460 x D560 x H890mm



NCL - 005
W440 x D560 x H890mm



NCL - 006
W450 x D565 x H910mm



NCL - 007
W450 x D560 x H890mm



NCL - 008
W570 x D460 x H890mm



NCL - 009
W570 x D460 x H890mm



NCL - 010
W450 x D560 x H890mm

BONNY 宴会椅

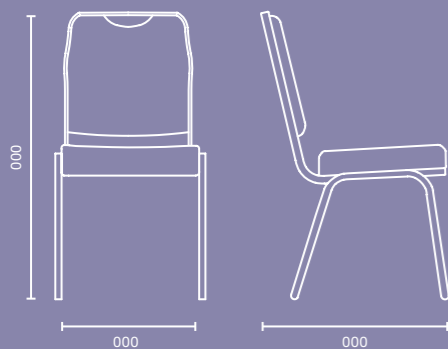

靠背框架
16 x 16 x 1.6 Thick (mm)

椅脚框架
19 x 19 x 1.2 Thick (mm)

- 特性:
- 机械自动焊接, 表面粉末涂层/电镀
 - 采用高密度定型海绵
 - 耐用脚垫
 - 腰背支撑



NRC - 001
W485 x D455 x H840mm



NRC - 002
W550 x D455 x H840mm



NRC - 003
W550 x D390 x H900mm



NRC - 004
W540 x D460 x H880mm



NRC - 005
W550 x D455 x H880mm



NRC - 006
W560 x D450 x H890mm



NRC - 007
W480 x D460 x H850mm



NRC - 008
W500 x D450 x H880mm



NRC - 009
W480 x D410 x H870mm



NRC - 011
W475 x D450 x H875mm



NRC - 012
W500 x D450 x H800mm



NRC - 013
W500 x D450 x W800mm



NRC - 014
W510 x D470 x H850mm



NRC - 015
W490 x D460 x H880mm

宴会椅推车

BCT-01

尺寸
W381 x D686 x H1067mm

- 材料**
- 铁管表面喷粉处理
 - 8英寸耐用无痕滑轮
 - 软毛垫托架
 - 可堆叠多达10张椅子



木制儿童椅

BB-01

尺寸
W445 x D455 x H800mm

- 特性**
- 带安全带
 - 软包坐垫



宴会椅推车

BCT-02

尺寸
W407 x D1220 x H1118mm

- 材料**
- 铁管表面喷粉处理
 - 配备4滑轮 (3英寸2轮和8英寸2轮)
 - 易于移动, 便于运送椅子
 - 软毛垫托架
 - 可堆叠多达10张椅子



运送推车

CT-03

尺寸
W508 x D610 x H153mm

- 特性**
- 可堆叠10张椅子
 - 软毛垫托架
 - 耐用滑轮



儿童椅

BB-01

尺寸
559 x D394 x H889mm

框架
铁艺框架表面喷粉处理

软包
PVC 人造革

特性
可上翻塑料托盘, 带安全带



运送推车

CT-04

尺寸
W508 x D1194 x H153mm

- 特性**
- 可堆叠10张椅子
 - 软毛垫托架
 - 耐用滑轮



桌子

为任何场合提供便利。我们众多系列的产品都使用加厚的脚管，并且配合起到加强支撑的辅助管，确保桌子能够长时间使用。桌子还配有腿折叠弹簧，使桌子可堆叠和容易操纵。此外，采用耐用尼龙胶塞安装在桌脚上，以防止折叠时掉落，并防止在不平整的表面打滑。



特性:

- 加强脚管，配上支撑管
- 耐用折叠弹簧配件
- 耐用尼龙堆叠垫和不易脱落脚塞



折叠式长方桌

桌面

- 表面覆盖人造革
- 18mm 防水夹板配PU封边

桌架尺寸:

- 尺寸: W32mm x D32mm x Thick 1.2mm
- 铁框架
- 表面防锈处理, 黑色喷粉

特性

- 加强脚管, 配上支撑管
- 耐用折叠弹簧配件
- 耐用尼龙堆叠垫和不易脱落脚塞



Model No	W x L x H (H2) mm	Model No	W x L x H (H2) mm
NRCT 18/60	460 x 1524 x 760 (115)	NRCT 24/84	610 x 2134 x 760 (115)
NRCT 24/60	610 x 1524 x 760 (115)	NRCT 30/84	760 x 2134 x 760 (115)
NRCT 30/60	760 x 1524 x 760 (115)	NRCT 36/84	915 x 2134 x 760 (115)
NRCT 36/60	915 x 1524 x 760 (115)	NRCT 18/96	460 x 2438 x 760 (115)
NRCT 18/72	460 x 1830 x 760 (115)	NRCT 24/96	610 x 2438 x 760 (115)
NRCT 24/72	610 x 1830 x 760 (115)	NRCT 30/96	760 x 2438 x 760 (115)
NRCT 30/72	760 x 1830 x 760 (115)	NRCT 36/96	915 x 2438 x 760 (115)
NRCT 36/72	915 x 1830 x 760 (115)		
NRCT 18/84	460 x 2134 x 760 (115)		

折叠式新月桌



Model No	DIA x H (H2) (mm)
NRDT 24	610 x 760 (115)
NRDT 30	760 x 760 (115)
NRDT 36	915 x 760 (115)
NRDT 42	1067 x 760 (115)
NRDT 48	1219 x 760 (115)
NRDT 54	1372 x 760 (115)
NRDT 60	1524 x 760 (115)
NRDT 66	1676 x 760 (115)
NRDT 72	1830 x 760 (115)
NRDT 84	2134 x 760 (115)

折叠式方桌



Model No	DIA x H (H2) (mm)
NSQT 24	610 x 610 x 760 (115)
NSQT 30	760 x 760 x 760 (115)
NSQT 36	910 x 910 x 760 (115)
NSQT 42	1060 x 1060 x 760 (115)
NSQT 48	1220 x 1220 x 760 (115)
NSQT 24	610 x 610 x 760 (115)
NSQT 30	760 x 760 x 760 (115)
NSQT 36	910 x 910 x 760 (115)
NSQT 42	1060 x 1060 x 760 (115)
NSQT 48	1220 x 1220 x 760 (115)

折叠式圆桌



Model No	DIA x H (H2) (mm)
NRDT 24	610 x 760 (115)
NRDT 30	760 x 760 (115)
NRDT 36	915 x 760 (115)
NRDT 42	1067 x 760 (115)
NRDT 48	1219 x 760 (115)
NRDT 54	1372 x 760 (115)
NRDT 60	1524 x 760 (115)
NRDT 66	1676 x 760 (115)
NRDT 72	1830 x 760 (115)
NRDT 84	2134 x 760 (115)

折叠式圆桌



Model No	W x L x H (H2) mm	Model No	W x L x H (H2) mm
NRCT 18/60	460 x 1524 x 760 (115)	NRCT 18/96	460 x 2438 x 760 (115)
NRCT 24/60	610 x 1524 x 760 (115)	NRCT 24/96	610 x 2438 x 760 (115)
NRCT 30/60	760 x 1524 x 760 (115)	NRCT 30/96	760 x 2438 x 760 (115)
NRCT 36/60	915 x 1524 x 760 (115)	NRCT 36/96	915 x 2438 x 760 (115)
NRCT 18/72	460 x 1830 x 760 (115)		
NRCT 24/72	610 x 1830 x 760 (115)		
NRCT 30/72	760 x 1830 x 760 (115)		
NRCT 36/72	915 x 1830 x 760 (115)		
NRCT 18/84	460 x 2134 x 760 (115)		
NRCT 24/84	610 x 2134 x 760 (115)		
NRCT 30/84	760 x 2134 x 760 (115)		
NRCT 36/84	915 x 2134 x 760 (115)		

桌子配件



桌子运送推车(NFTT-1002)
W915 x D1980 x H1120mm



桌子运送推车 (NRTT-1003)
W915 x D1980 x H1120mm

索玛宴会桌

桌面

表面覆盖白色人造革
8mm防水夹板芯材
全包耐用PU封边天

桌架

- V形桌脚, 32x32x1.2mm脚管
- 铁艺结构
- 表面黑色防锈铁喷粉

特性

- 加强脚管, 配上支撑管
- 耐用折叠弹簧配件
- 耐用尼龙堆叠垫和不易脱落脚塞



Model No	W x L x H1 (mm)
CNCT - D - 30/60	760 x 1504 x 760
CNCT - D - 30/70	760 x 1830 x 760
CNCT - D - 30/84	760 x 2438 x 760

伍肯会议桌



桌面

15mm防水夹板芯材, 表面合成板, PU封边

脚架

铁电镀/喷粉脚架

可叠新月桌T型脚架

桌面
18mm防水夹板芯材, 表面合成板, PU封边

脚架
铁电镀/喷粉脚架

Model No	W x L x H1 (mm)
CNCT - D - 30/60	760 x 1504 x 760
CNCT - D - 30/70	760 x 1830 x 760
CNCT - D - 30/84	760 x 2438 x 760



方形单柱桌

桌面
18mm防水夹板芯材, 表面合成板, PU封边

脚架
铁电镀/喷粉脚架

Model No	W x L x H1 (mm)
CSQT - D - 24	610 x 610 x 760
CSQT - D - 30	760 x 760 x 760
CSQT - D - 36	915 x 915 x 760



可叠半圆桌T型脚架

桌面
18mm防水夹板芯材, 表面合成板, PU封边

脚架
铁电镀/喷粉脚架

Model No	W x L x H1 (mm)
CHRT - D - 24/48	610 x 1220 x 760
CHRT - D - 30/60	760 x 1524 x 760
CHRT - D - 36/72	915 x 1830 x 760



椭圆桌

桌面
18mm防水夹板芯材, 表面合成板, PU封边

脚架
铁电镀/喷粉脚架

Model No	W x L x H1 (mm)
CORT - D - 59/71	1500 x 1800 x 760
CORT - D - 47/83	1200 x 2100 x 760



1/4圆单柱桌

桌面
18mm防水夹板芯材, 表面合成板, PU封边

脚架
铁电镀/喷粉脚架

Model No	W x L x H1 (mm)
CQRT - D - 30	760 x 760 x 760
CQRT - D - 36	915 x 915 x 760



莫德长方形桌

配固定双面板/单向折叠前挡板

桌面

15mm防水夹板芯材, 表面合成板, PU封边

桌架

铁电镀/喷粉脚架

Model No	W x L x H (H2) (mm)
CRCT - MPD/D 30/48	762 x 1220 x 760 (115)
CRCT - MPD/D 18/60	460 x 1524 x 760 (115)
CRCT - MPD/D 18/72	460 x 1830 x 760 (115)
CRCT - MPD/D 21/72	534 x 1830 x 760 (115)
CRCT - MPD/D 24/72	610 x 1830 x 760 (115)
CRCT - MPD/D 30/72	760 x 1830 x 760 (115)
CRCT - MPD/D 36/72	915 x 1830 x 760 (115)
CRCT - MPD/D 30/96	760 x 2438 x 760 (115)



莫德长方形桌

木纹可拆卸前挡板

桌面

15mm防水夹板芯材, 表面合成板, PU封边

桌架

铁电镀/喷粉脚架

Model No	W x L x H (H2) (mm)
CRCT - WDP - 30/48	762 x 1220 x 760 (115)
CRCT - WDP - 18/60	460 x 1524 x 760 (115)
CRCT - WDP - 18/72	460 x 1830 x 760 (115)
CRCT - WDP - 21/72	534 x 1830 x 760 (115)
CRCT - WDP - 24/72	610 x 1830 x 760 (115)
CRCT - WDP - 30/72	760 x 1830 x 760 (115)
CRCT - WDP - 36/72	915 x 1830 x 760 (115)
CRCT - WDP - 30/96	760 x 2438 x 760 (115)



可叠长方桌

配T型桌架

桌面

15mm防水夹板芯材, 表面合成板, PU封边

桌架

铁电镀/喷粉脚架

Model No	W x L x H (H2) (mm)
CRCT - T - D - 30/48	762 x 1220 x 760 (115)
CRCT - T - D - 18/60	460 x 1524 x 760 (115)
CRCT - T - D - 18/72	460 x 1830 x 760 (115)
CRCT - T - D - 21/72	534 x 1830 x 760 (115)
CRCT - T - D - 24/72	610 x 1830 x 760 (115)
CRCT - T - D - 30/72	760 x 1830 x 760 (115)
CRCT - T - D - 36/72	915 x 1830 x 760 (115)
CRCT - T - D - 30/96	760 x 2438 x 760 (115)



莫德长方形桌

可拆卸前挡板

桌面

15mm防水夹板芯材, 表面合成板, PU封边

桌架

铁电镀/喷粉脚架

Model No	W x L x H (H2) (mm)
CRCT - DFP/D - 30/48	762 x 1220 x 760 (115)
CRCT - DFP/D - 18/60	460 x 1524 x 760 (115)
CRCT - DFP/D - 18/72	460 x 1830 x 760 (115)
CRCT - DFP/D - 21/72	534 x 1830 x 760 (115)
CRCT - DFP/D - 24/72	610 x 1830 x 760 (115)
CRCT - DFP/D - 30/72	760 x 1830 x 760 (115)
CRCT - DFP/D - 36/72	915 x 1830 x 760 (115)
CRCT - DFP/D - 30/96	760 x 2438 x 760 (115)



前台

(箱型桌)

桌面

15mm防水夹板芯材, 表面合成板, PU封边

桌架

黑色铁喷粉脚架

特性

木纹装饰板配PU封边, 3边围封

Model No	W x L x H (H2) (mm)
CRCT - P - 18/60	460 x 1524 x 762
CRCT - P - 24/60	610 x 1524 x 762
CRCT - P - 30/60	762 x 1524 x 762
CRCT - P - 36/60	915 x 1524 x 762
CRCT - P - 18/72	458 x 1829 x 762
CRCT - P - 24/72	610 x 1829 x 762
CRCT - P - 30/72	762 x 1829 x 762
CRCT - P - 36/72	915 x 1829 x 762



酒会桌

可折叠/固定单柱酒会桌

桌架
表面电镀/喷粉处理

脚轮
耐用可固定脚轮

封边
铝封边/PVC封边/Dura油漆封边

Model No	DIA x H (mm)
NCTL - FT - D/PDW - 24D	610 x 1067
NCTL - FT - D/PDW - 30D	760 x 1067
NCTL - FT - D/PDW - 36D	815 x 1067



可折叠/固定酒会桌

桌面
装饰面配PVC封边

桌脚
铁艺独柱桌面, 表面喷粉/电镀处理

滑轮
耐用可固定滑轮, 可升降气动杆

Model No	DIA x H (mm)
NCTL - FT - AW - 24	610 x 760 - 915
NCTL - FT - AW - 30	760 x 760 - 915
NCTL - FT - AW - 36	910 x 760 - 915



可折叠/固定酒会桌

喇叭形桌脚

NFTCT-101

桌面
装饰面配PVC封边

桌脚
表面电镀处理

Model No	DIA x H (mm)
NFTCT-101-24	610 x 1067
NFTCT-101-30	760 x 1067
NFTCT-101-39	815 x 1067



可折叠/固定就会桌

独柱桌脚

NCTL - FT/D/TL - 30D

桌面
装饰面配PVC封边

桌脚
铁艺独柱桌脚, 表面黑色喷粉处理

Model No	DIA x H (mm)
NCTL - FT/D/TL - 24D	610 x 1067
NCTL - FT/D/TL - 30D	760 x 1067
NCTL - FT/D/TL - 36D	815 x 1067



酒桌桌

材料
铁艺表面喷粉处理

桌面
12mm钢化玻璃

桌脚
喇叭型桌架

Model No	DIA x H (mm)
NCTL - WI - 30D	760 x 1067
NCTL - WI - 36D	915 x 1067



可折叠酒会桌

材料
铸铁表面黑色喷粉

玻璃桌面
10mm钢化玻璃

特性
2片合页和4片脚塞

Model No	DIA x H (mm)
NCTC - WI/PI - 30D	760 x 1068
NCTC - WI/PI - 36D	915 x 1068



定制可折叠自助餐桌

框架
铁艺表面喷粉处理

玻璃桌面
10mm钢化清玻璃

特性
可折叠便于存放

Model No	DIA x H (mm)
NFBT - SS - 106	760 x 1067



定制可折叠方形自助餐桌

框架
304不锈钢拉丝/铁艺喷粉

玻璃桌面
10mm 钢化清玻璃

特性
可折叠便于存放

Model No	W x L x H (mm)
NCTL - SS - 26D	610 x 650 x 1050



定制可折叠两层自助餐桌

框架
304不锈钢拉丝/铁艺喷粉

玻璃桌面
钢化清玻璃

特性
可折叠便于存放

Model No	DIA x H (mm)
NCTL - 2T - SS - 28D	700 x 1050



长方形自助餐桌 一套4张

框架爱
304不锈钢拉丝/铁艺喷粉

玻璃桌面
12mm钢化清玻璃

Model No	W x L x H (mm)
NBFT - RG - SS- SET4	760 x 1150 x 695
	760 x 1300 x 830
	760 x 1450 x 965
	760 x 1600 x 1100



方形自助餐桌

一套4张

框架

304不锈钢拉丝/铁艺喷粉

玻璃桌面

12mm钢化清玻璃

Model No	W x L x H (mm)
NBFT - SQT - SS - SET4	760 x 760 x 695
	910 x 910 x 830
	1060 x 1060 x 965
	1210 x 1210 x 1100



长方移动自助餐桌

框架

304不锈钢拉丝/铁艺喷粉

桌面

18mm防水芯材双面木纹装饰板PU封边

特性

可折叠便于存放

Model No	W x L x H (mm)
NBFT - RCT/SS - 35/51	900 x 1300 x 760



三角自助餐桌

一套4张

框架

304不锈钢拉丝/铁艺喷粉

玻璃桌面

12mm钢化清玻璃

Model No	W x L x H (mm)
NBFT - TRG - SS - SET4	760 x 760 x 695
	910 x 910 x 830
	1060 x 1060 x 965
	1210 x 1210 x 1100



方形移动自助餐桌

框架

304不锈钢拉丝/铁艺喷粉

桌面

12mm钢化清玻璃

特性

可折叠便于存放

Model No	W x L x H (mm)
NBFT - SQT/SS - 35/35	900 x 900 x 760



半圆自助餐桌

一套4张

框架

304不锈钢拉丝/铁艺喷粉

玻璃桌面

12mm钢化清玻璃

Model No	W x L x H (mm)
NBFT - HRT - SS - SET4	380 x 760 x 695
	455 x 910 x 830
	530 x 1060 x 965
	605 x 1210 x 1100





方形移动自助餐桌

框架

304不锈钢拉丝/铁艺喷粉

桌面

18mm防水芯材双面木纹装饰板PU封边

Model No	W x L x H (mm)
NBFT - SQT/SS - 18/48H	450 x 450 x 1200



递增多层自助餐桌

框架

304不锈钢拉丝/铁艺喷粉

桌面

12mm钢化清玻璃

Model No	W x L x H (mm)
NBFT - SQT - 33/54H	838 x 838 x 1372



机动长方堆插自助餐桌

框架

铸铁表面黑色喷粉

桌面

12mm钢化清玻璃

Model No	W x L x H (mm)
NBFT - RCT - WI - SET3	1524 x 712 x 712
	1675 x 815 x 813
	1830 x 915 x 915



移动舞台



安装指南

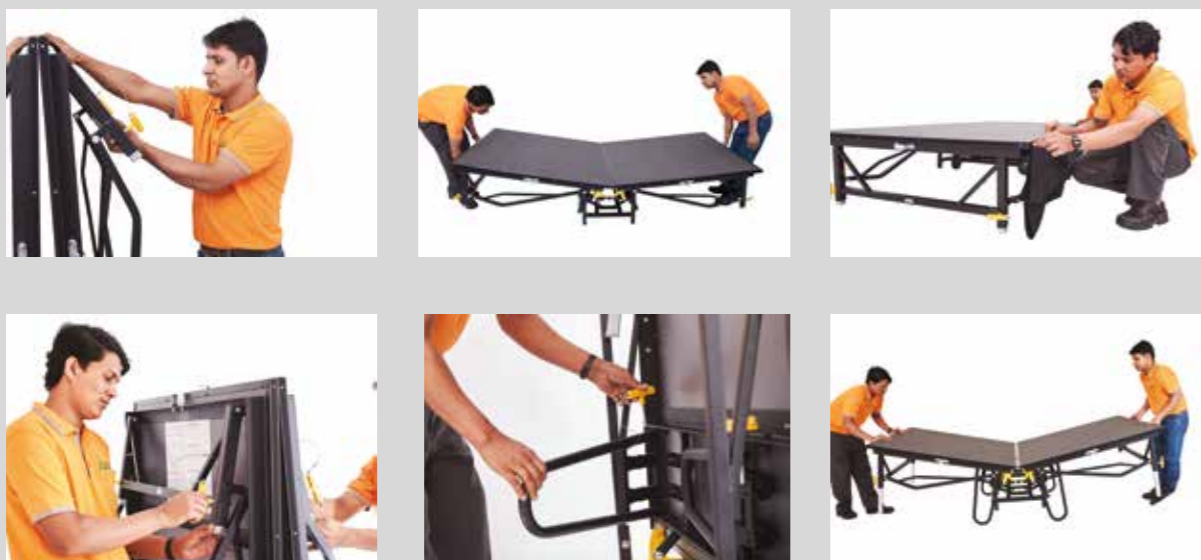

移动舞台

框架
黑色铁艺可折叠

- 特性**
- 耐用框架, 使用侧边链接
 - 4轮可移动折叠舞台
 - 无需搬运重物, 无需专人存放

Single Height Stage

Model No	Size (mm)
NMSS- 610	230
NMSS- 611	410
NMSS- 612	610
NMSS- 613	810

Dual Height Stages

Model No	Size (mm)
NMSD - 620	410 x 610
NMSD - 621	610 x 819
NMSD - 622	810 x 102

Tri Height Stages

Model No	Size (mm)
NMST - 630	460 x 610 x 760
NMST - 631	610 x 760 x 910



舞台围边

尺寸
2440mm Length

颜色选择
黑色/褐红色

特性

- 丝绒皱褶样式
- 可选择 单边, 双边 或 三边魔术贴封口



布吉自接便携舞蹈地板

NPDF - 201
(配备自接链接件)
W915 x D915 x H25mm

特性

- 柚木条板 50.8 x 305
- 免钉自接链接件
- 最新设计和便捷组装
- 材料耐用, 易清洁和表面维护易



踏板架

特性

- 黑色喷粉铁艺
- 固定高度

Model	L x W x H (mm)	Platform
NTSR - 640	966 X 660 X 407	Chequer plated top
NTSR - 641	966 x 660 1372	Carpeted
NTSR - 642	966 x 978 x 610	Carpeted
NTSR - 643	966 x 978 x 1600	Carpeted



NTSR - 640
2层无扶手踏板架



NTSR - 642
3层无扶手踏板架



NTSR - 641
2层带扶手踏板架



NTSR - 643
3层带扶手踏板架

布吉便携舞蹈地板

NPDF - 202
W922 x D922 x H25mm

芯材
50 x 300 x 8mm 优等柚木

表面
优选6mm篮编柚木镶嵌

封边
6mm定型铝母链接, 保护边缘并链接调平

特性
方形柚木地板
内六角螺丝组合



布吉便携舞蹈地板收边

NCBT - 203
W127mm

NCBT - 204
W127mm

新设计自锁舞蹈地板直封边(DFTT-SL-01)

新设计自锁舞蹈地板转角封边 (DFTT-SL-02)

颜色
银色/金色



NCBT - 203 (DFTT-SL-01)



NCBT - 204 (DFTT-SL-02)

定制讲台

NSR - 710
W510 x L1070 x H1250mm

特性

- 内高度900mm
- 内宽400mm
- 3层可调节高度层板可以在内高300mm内活动, 10mm边高防止操作时候花落
- 3英寸耐用滑轮 (2个直轮, 2个万向轮)



定制讲台

NST - 740
W546 x L565 x H1360mm

特性

- 不锈钢配木纹饰板
- 麦克风前抽拉式放倒挡板
- 2伏专业聚光灯 14英寸项形立柱
- 2英寸滑轮 (2个直轮+2个可固定万向轮)
- 微倾阅读台
- 1个阅读灯
- 1个电源键
- 1个音频插口
- 1个VGA接口
- 1个3孔插座



站立式讲台

NSR - 720
W510 x L1070 x H1250mm

材料

- 实木与不锈钢结构

配件

- 亚克力标志
- 阅读灯
- 麦克风控制
- 电源键



V型讲台

NVR - 750
W547 x L737 x H1156mm

材料

- 胡桃木色实木主体配不锈钢拉丝底座

配件

- 亚克力标志
- 阅读灯
- 麦克风接口
- 电源接口



站立式讲台

NSR - 730
W550 x L570 x H1170mm

材料

- 实木与不锈钢结构

配件

- 亚克力标志
- 阅读灯
- 麦克风控制
- 电源键
- 配备2英寸耐用滑轮 2个可固定万向轮, 2个直滑轮



前台手推车

令您的顾客轻松入住,使用前台手推车给他们最周到的款待。多种形状和大小供选择,以满足您的客户的需求。框架采用不锈钢制造,经久耐用强负重,并安装了加厚进口脚轮,操作便利。



鸟笼推车

NFOT - SS/H - 901
L1168 x W710 x H1854mm

框架
304 不锈钢50.8x1.5mm 机械弯管框架

表面处理
· 表面拉丝
· 喷粉框架
· PVD防锈处理

滑轮
进口203mm实心滑轮,2个直轮 和 2个万向轮。橡胶防撞全包围

软毛垫颜色
深灰/褐红



行李推车

NFOT - SS/H - 904
L1168 x W686 x H1778mm

框架
304 不锈钢50.8x1.5mm 机械弯管框架

滑轮
进口203mm实心滑轮,2个直轮 和 2个万向轮。橡胶防撞全包围

软毛垫颜色
深灰/褐红



鸟笼推车

NFOT - SS/H - 902
L1168 x W710 x H1854mm

框架
304 不锈钢50.8x1.5mm 机械弯管框架

表面处理
· 表面拉丝
· 喷粉框架
· PVD防锈处理

滑轮
进口203mm实心滑轮,2个直轮 和 2个万向轮。橡胶防撞全包围

软毛垫颜色
深灰/褐红



行李推车

NFOT - SS/H - 905
L1168 x W686 x H1778mm

框架
304 不锈钢50.8x1.5mm 机械弯管框架

滑轮
进口203mm实心滑轮,2个直轮 和 2个万向轮。橡胶防撞全包围

软毛垫颜色
深灰/褐红



鸟笼推车

NFOT - SS/H - 903
L1168 x W710 x H1854mm

框架
304 不锈钢50.8x1.5mm 机械弯管框架

表面处理
· 表面拉丝
· 喷粉框架
· PVD防锈处理

滑轮
进口203mm实心滑轮,2个直轮 和 2个万向轮。橡胶防撞全包围

软毛垫颜色
深灰/褐红



手推车

NFOT - SS/H - 906
L1168 x W686 x H1778mm

框架
304 不锈钢50.8x1.5mm 机械弯管框架

滑轮
进口203mm实心滑轮,2个直轮 和 2个万向轮。橡胶防撞全包围

软毛垫颜色
深灰/褐红



后勤手推车

使用我们手推车帮助您快速完成的房间清洁和整理。
从多功能到简易款式
我们产品种类繁多总能为您提供适合各种场合。我们的手推车设有分开存放干净的床单的隔层，并且带有各类清洁工具存放，让你管家服务提高效率和轻松完成。



查美手推车

NHFT - MS - 101

尺寸

1524 L x 584 W x 1168 H (mm)

长收纳袋尺寸

460 L x 270 W x 825 H (mm)

短收纳袋尺寸

460 L x 270 W x 573 H (mm)

材料

两侧配有长收纳袋和短收纳袋。203mm耐用滑轮和四边防撞橡胶圈

框架

表面喷粉
象牙色15200/ 金属铜/ 闪耀银铁

帆布收纳袋颜色

棕色/黑色/蓝色



查美手推车

NHKT - MS/TO/DR - 102

W575 x L1490 x H1235mm

特性

- 帆布储存袋
- 铁艺喷粉框架
- 滑轮:2个直轮和2个360度转轮



查美手推车

NHKT - MS - 105

W600 x L1545 x H1185mm

特性

- 帆布储存袋
- 铁艺喷粉框架
- 滑轮:2个直轮和2个360度转轮



查美手推车

NHKT - MS/TO/NEW - 104

W575 x L1520 x H1530mm

特性

- 帆布储存袋
- 铁艺喷粉框架
- 滑轮:2个直轮和2个360度转轮
- 可选配:管理挂架





查美手推车

NHKT - MS/S - 105
W580 x L1490 x H1230mm

特性

- 帆布储存袋
- 铁艺喷粉框架
- 滑轮:2个直轮和2个360度转轮
- 可选配:管理挂架



3分类袋手推车

NHKT - MS/3 - 106
3个帆布袋
W545 x L1180 x H910mm

框架

铁艺喷粉, 橡胶防撞全包围

滑轮

155mm耐用滑轮

颜色

蓝色/棕色/黑色



威特手推车

NHKT - MS/VT - 108
W555 x L1155 x H1715mm

特性

- 不锈钢挂架, 铁艺喷粉框架
- 平台橡胶防撞全包围

滑轮

155mm耐用滑轮



玻璃钢手推车

NHKT - FG - 109
W686 x L966 x H925mm

材料
玻璃钢

滑轮
4个155mm耐用滑轮

特性
橡胶防撞全包围



网格手推车

NHKT - MS/PC/DR - 112
(不带门)
W575 x L1135 x H1445mm

NHKT - MS/PC/WD - 113
(带门)
选配拉门

滑轮
155mm耐用滑轮

特性
铁艺粉喷框架,带一面门,两片可移动层板
橡胶防撞全包围



网格手推车

NHKT - MS/ST - 110
W700 x L1005 x H900mm

滑轮
155mm耐用滑轮

特性
铁艺喷粉框架,配用帆布袋,橡胶防撞全包围

颜色
蓝色/棕色/黑色



手推车

NHKT - SS/PT - 114
W750 x L1160 x H1070mm

材料
304不锈钢
配204mm耐用滑轮



X型手推车

NHKT - MS/XF - 111
W625 x L850 x H915mm

框架
304不锈钢25x1.2mm

滑轮
4个100mm耐用滑轮

特性
耐用尼龙袋

颜色
蓝色/棕色/黑色



手推车

NHKT - MS/PT - 115
W750 x L1190 x H1120mm

材料
铁艺粉喷框架 配204mm耐用滑轮



网格手推车

NHKT - MS/PC/B - 116
W690 × L985 × H905mm

框架
铁艺粉喷, 中间分隔, 橡胶防撞全包围

滑轮
155mm 耐用滑轮



单杆衣架

NHKT - SS/ST - 119
W500 x L1520 x H1945mm

材料
304不锈钢拉丝框架, 25x1.2mm圆管

滑轮
4个100mm万向准轮



网格手推车

NHKT - MS/PC - 117
W690 x L985 x H905mm

框架
铁艺粉喷, 橡胶防撞全包围

滑轮
155mm 耐用滑轮



双杆衣架

NHKT - SS/DT - 120
W625 x L1520 x H1755mm

材料
304不锈钢, 32x1.2mm机械弯管框架

滑轮
4个100mm万向准轮



衣帽架

NHKT - SS/CH - 118
Ø331 x H1855mm

材料
· 304不锈钢
· 38x1.2mm 圆管



衣架

NHKT - SS/GT - 121
W500 x L1510 x H1910mm

材料
304不锈钢拉丝框架, 25x1.2mm圆管

滑轮
4个100mm万向准轮



德米架子

NHKT - MS/PC/DW - 122
W483 x L508 x H813mm

材料
铁艺

特性
轻量耐用尼龙带

颜色
表面喷粉/电镀处理



双层可折叠餐架

NHKT - WD/TS/2 - 127
W400 x L580 x H900mm

特性
红褐色实木架子, 易于储藏



行李架

NHKT - MS/PC/BR - 124
W485 x L610 x H660mm

材料
圆管铁艺
防撞后管
特制可更换挂钩配耐用尼龙带

颜色
表面喷粉/电镀处理



实木可以折叠餐架

NHKT - WD/TS - 128
W407 x L585 x H890mm

特性
红褐色实木架子, 配耐用尼龙带



行李架

NHKT - MS/PC - 125
W508 x L610 x H610mm

材料
· 圆管铁艺
· 防撞后管
· 特制可更换挂钩配耐用尼龙带

颜色
· 表面喷粉/电镀处理



实木餐架

NHKT - WD/LR - 129
W432 x L762 x H635mm

材料
红褐色实木架子, 配耐用尼龙带

**尼龙带颜色棕色/黑色



苏珊玻璃桌面配 固定底座

NBQT - LFB - 201

特性
12mm厚度, 边缘打磨

玻璃尺寸
Ø760mm (30")
Ø815mm (32")
Ø915mm (36")

厚度
10mm & 12mm

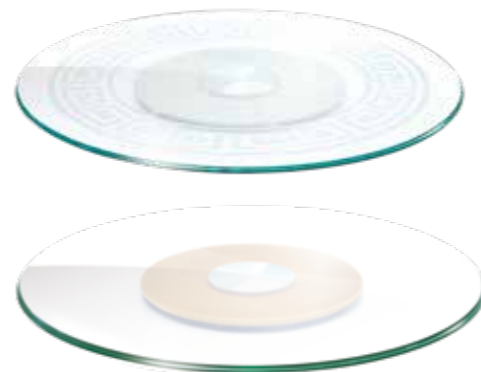

镜面处理PU封边

NBQT - GL/M/PU - 203

玻璃尺寸
Ø760mm (30")
Ø815mm (32")
Ø915mm (36")

厚度
10mm & 12mm



钢化清玻璃中心 磨砂台面

NBQT - GL/CT

玻璃尺寸
Ø760mm (30")
Ø815mm (32")
Ø915mm (36")

厚度
10mm & 12mm



钢化清玻璃配可 旋转铝环

NBQT - GL/CT/R - 30/36/40/48

玻璃尺寸
Ø760mm (30")
Ø915mm (36")
Ø1016mm (40")
Ø1219mm (48")

厚度
10mm

可旋转铝环可选配滚珠尺寸:16/18/20/24" 随着桌面尺寸应增加使用尺寸



磨砂玻璃

NBQT - GL/FFT - 202

玻璃尺寸
Ø760mm (30")
Ø815mm (32")
Ø915mm (36")

厚度
10mm & 12mm



苏珊手推

NBQT - MS/LTR - 301 (20 NOS)

特性

- 可定制装载量20张桌面
- 可存放42-24英寸圆玻璃桌面, 配上底圆环
- 配置圆屋顶式底座, 安全防火护栏



可伸缩队伍栏杆

NBQT - RQ/SS - 801
W635 x L1067 x H1448mm

材料
不锈钢

伸缩带子厂度
180cm

伸缩带颜色
红色/黑色/ 蓝色



耐用队伍栏杆

NBQT - QS/SS - 804
Ø330 x H1016mm

材料
· 304不锈钢
· 镀金处理



可伸缩队伍栏杆

NBQT - RQ/SS/PC - 802
Ø331 x H915mm

材料
不锈钢表面喷黑色粉

伸缩带子厂度
180cm

伸缩带颜色
红色/黑色/ 蓝色



桌面号码牌

NBQT - TN/MS - 805
Ø115 x H445mm

材料
铁电镀支架, 双面亚克力数字号码牌



可伸缩队伍栏杆

NBQT - RQ/SS/SB - 803
Ø331 x H915mm (stand only)

材料
不锈钢

伸缩带子厂度
180cm, 配A4指示牌架

伸缩带颜色
红色/黑色/ 蓝色



客房服务推车

三重系列



特性

我们提供多种客房服务桌子, 选择一款基本款满足您的需求。

- 桌面由18mm 防水芯材配装饰板制成, 底部带有塑料饰面, 耐用并易于维护
- PU封边覆盖每一个接口, 最大限度的保护手推车。
- 5英寸耐用PU无轮印滑轮, 使用时平滑安静
- 主框架使用25x50x1.6mm铁艺粉喷, 增加加强支撑管, 整架焊接。
- 使用尼龙螺丝在活动区域

客房服务推车- 圆桌面

圆桌面
NRST - MS/P/RD - 401
 Ø915mm x H78mm

椭圆桌面
NRST - MS/D/OV - 402
 W1067 x L915 x H787mm

方形桌面
NRST - MS/D/SQT - 403
 W915 x L915 x H787mm





电食物保温箱

NRST - SS/FW - 404
410 L x 370 W x 490 H (mm)

特性

- 双层框架结构, 防止箱体受外部热量, 同时保持箱体内部的热量外漏。
- 定制门锁, 保持门在使用期间紧密, 防止热量外漏。
- 顶部手柄和2侧手柄安装, 使其便于在操作期间携带
- 独立不锈钢合页加强结构
- 240伏特配一个三叉插座
- 配三层可移动铝层板
- 可选配外观黑色喷粉



保温器的外部由不锈钢制成, 便于维护和耐用。内部装有铝。这两种材料都是无锈卫生

食物保温箱移动架

NRST - MS/T - 405
W510 x L970 x H1675mm

特性

- 全焊铁艺 25x50x1.6mm框架
- 常规颜色哑光黑。
- 5英寸耐用PU滑轮, 易于移动
- 2个顶部刹车方式存放时移动
- 最大载量6件/车 (保温箱)





材料与色卡



AQUACLEAN®

Imported from Spain

当你的家具使用Aqua clean面料, 纺织物维护将会变得很简单。Aqua clean利用革命性的织物技术, 形成一个灵活的, 无形的分子层, 防止污垢渗透到织物。沙发上常见的酒渍、墨水、酱汁、脂肪、泥、巧克力、奶油等污渍, 只需要用水就可以清洗掉。这还不是它全部功能。如果你家里有宠物, 选择用Aqua clean面料装饰的家具, 享受一个更健康、更卫生的环境。Safe Front Hygiene保护层, 防止被宠物抓伤, 以及意外的尖锐物体划伤, 并更容易除宠物毛发。它还能对抗霉菌、细菌和螨虫, 尤其是儿童和老人。水产是无PFC和100%阻燃功能。

- 健康和卫生的家
- 简单, 容易维护的布料
- 只需水清洁
- 防止刮伤和勾线
- 平滑表面易于清洁宠物毛发
- 无PFC 和100%阻燃



步骤1

清理面料上残留物



步骤2

取适量的清水清洁污渍, 或通过沾水的毛巾沾湿。静待一分钟。



步骤3

请用湿布用轻压的打圈的方式吸走带污渍。若还有轻微污渍, 请重复清洁步骤。

了解更多关于 Aquaclean®



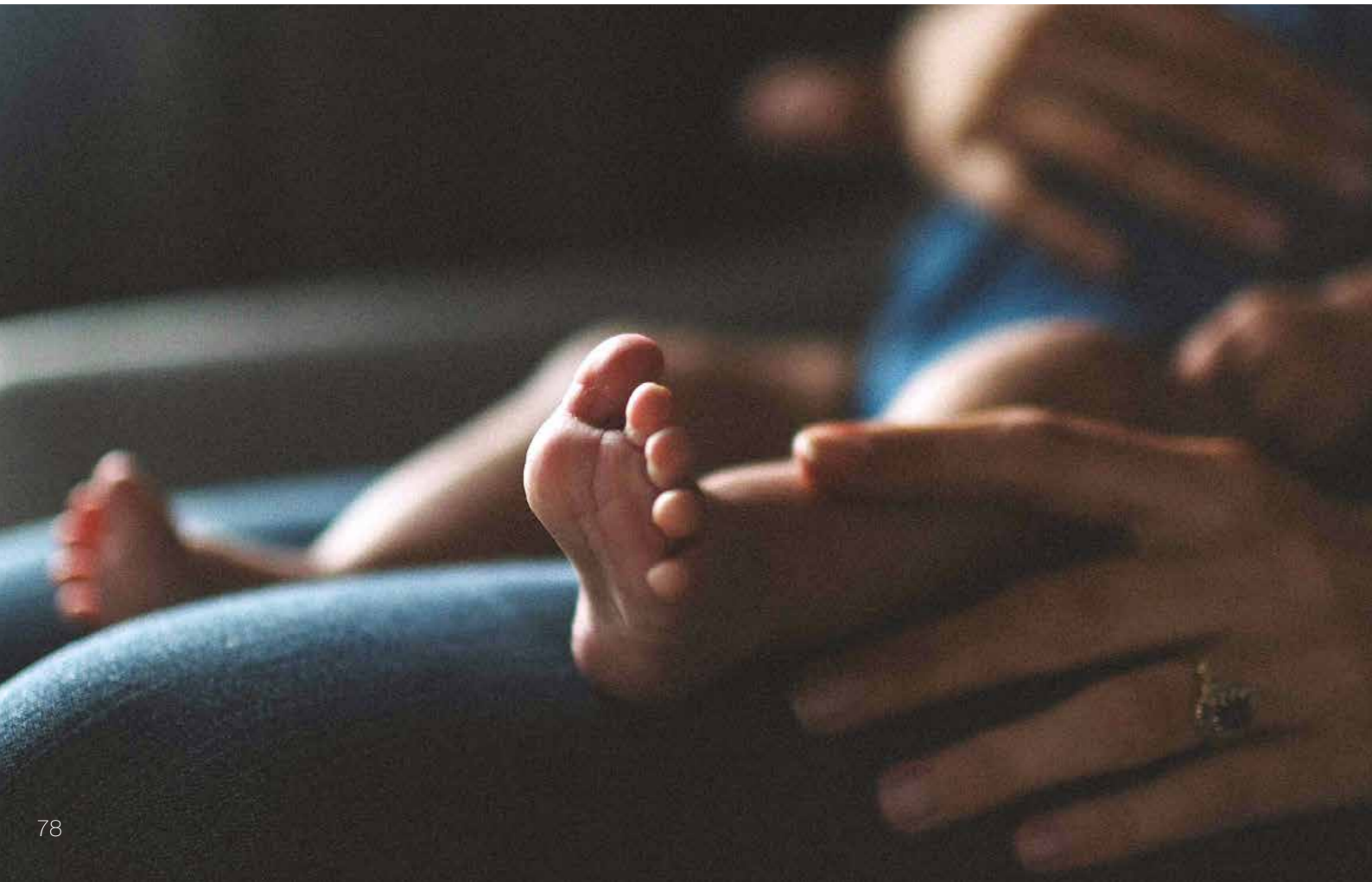

您的家具体验

世界上有多少人,就有多少种享受家具的方式。这就是为什么,在50多年前,我们决定创造出可以应付一切的面料。即使是意想不到的事。关于新冠肺炎疫情的相关信息,我们革命性的Aqua clean 面料和Safe Front 技术帮助您保持您的家具安全和卫生的新常态。因为对我们来说,我们希望您不用担心任何事情就能体验您的家具。

享受
您的家具
不带任何烦恼
任何顾虑

清洁表面, 洁净内在

从实验证明, Aquaclean 和 SafeFront被检测证明有效抑制病毒和细菌在面料上生长

SafeFront通过

ISO 20743:2013 8.1 检测标准验证

ISO 18184:2019

用于测定纺织品中的抗病毒活性,表明其对猫科动物冠状病毒(一种与COVID-19非常相似的病毒)的有效性超过91%。



扫一扫获得更多关于
Safe Front



Aquaclean 布料 常规净色



Mystic 1 Mystic 3 Mystic 5 Mystic 7 Mystic 8 Mystic 11

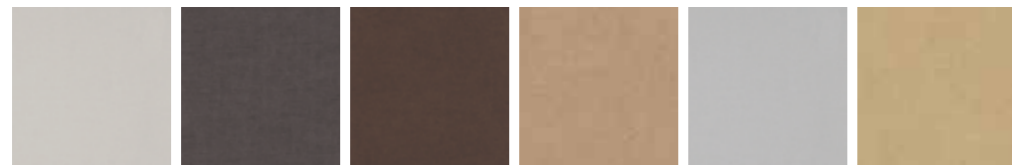

Mystic 12 Mystic 13 Mystic 15 Mystic 18 Mystic 21 Mystic 32



Mystic 38 Mystic 50 Mystic 51 Mystic 52 Mystic 56 Mystic 59



Mystic 61 Mystic 62 Mystic 64 Mystic 65 Mystic 66 Mystic 68

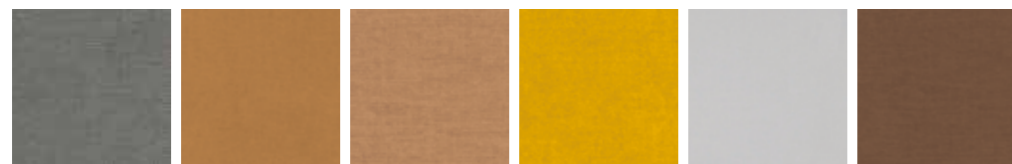

Mystic 69 Mystic 73 Mystic 104 Mystic 105 Mystic 112 Mystic 114



Mystic 131 Mystic 136 Mystic 144 Mystic 161 Mystic 187 Mystic 213

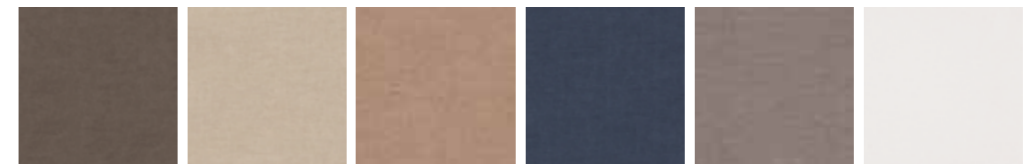

Mystic 214 Mystic 250 Mystic 252 Mystic 311 Mystic 313 Mystic 324



Mystic 373 Mystic 387 Mystic 395 Mystic 503 Mystic 510 Mystic 514

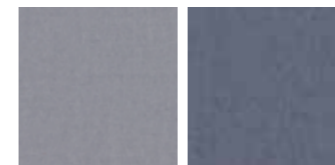

Mystic 602 Mystic 603

Aquaclean 布料 经典花纹布



Stamford 314 Stamford 324 Stamford 395

Cardiff 布料

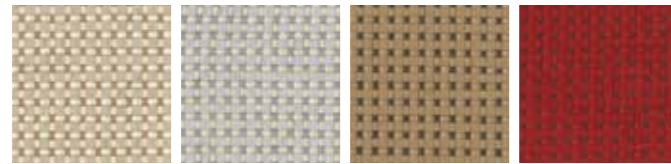

Sand CD145 Ivory CD167 Move CD187 Vibe CD110

Cortex 布料



Mist Blue 5213 Mustard 5155 Fern 5278 Claret 5238

Perth 布料



Aruba 270 Platinum 273 Pine Tree 262 Cherry 228

Pyramid 布料



Saffron PY8250 Juniper PY8269 Aqua Marina PY8268 Black PY8299

Lassen 布料



Navy 99120 Coco 99080 Greystone 99161 Kiwi 99070

Carpet 布料

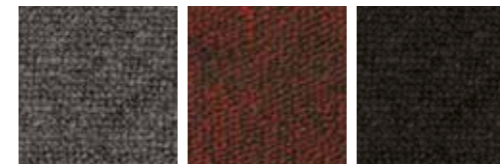

Dark Grey Maroon Black

电镀颜色



Rose Gold (RG3 ND) Champagne (C3 ND) Black Titanium (BT2 MR) Black Chrome (BCI HL) Gold (G3 ND) Bronze (BI HL)

防火板



Gold Teak A8902-M Coast Teak A8903-M Royal Teak A7826-M Elegant Teak A8103-M Wyre Wood A8602-M Sand Wenge A7805-M

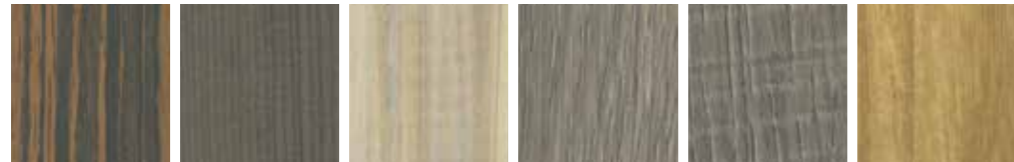

Light Zebra A7749-M Brownny Pine A8368-M Plank Oak A7900-M Smoked Oak A7817-M Nature Oak Evangle A8804-M Phanera Oak A7808-M

喷粉涂层颜色

特殊颜色

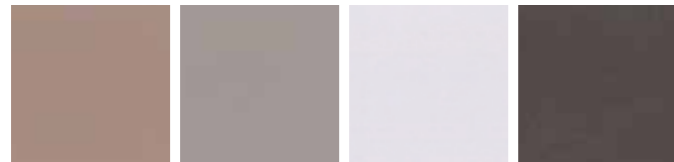

Rose Wood Manor Stone Morning Moon Maroon

常规净色

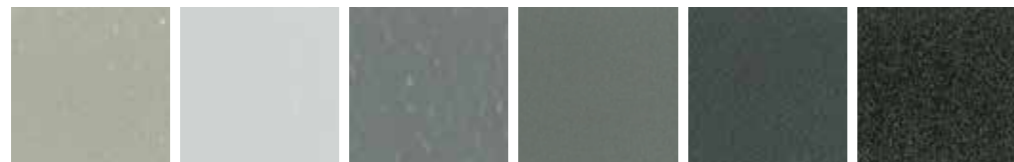

FF 160 / 202 / CW FF 160 / 805 / C9 FF 165 / 8938 / CW3 FF 165 / 8023 / CT36 FS / 8457 / CT13 FF 160 / K7375 / CT1

本册内所有照片, 人物形象, 图纸, 尺寸和照片仅作为说明参考。不作为实施参考, 随时会变更和修改。实物和细节可能与照片有差别。未经许可请勿随意仿制或使用本册内容作为商业用途。

Copyright © 2020 KIAN Group of Companies
All Rights Reserved



Kian® 健

Better Design, Better Value, Better World

 www.kian.com.cn

 hello@kian.com

 KIAN健

KHOSE2021.03